

www.ip-com.com.cn

User Guide

Gigabit Cloud Managed Switch

IP-COM
World Wide Wireless

Copyright statement

Copyright © 2021 IP-COM Networks Co., Ltd. All rights reserved.

IP-COM is the registered trademark of IP-COM Networks Co., Ltd. Other brand and product names mentioned herein are trademarks or registered trademarks of their respective holders. Copyright of the whole product as integration, including its accessories and software, belongs to IP-COM Networks Co., Ltd. No part of this publication can be reproduced, transmitted, transcribed, stored in a retrieval system, or translated into any language in any form or by any means without the prior written permission of IP-COM Networks Co., Ltd.

Disclaimer

Pictures, images and product specifications herein are for references only. To improve internal design, operational function, and/or reliability, IP-COM reserves the right to make changes to the products described in this document without obligation to notify any person or organization of such revisions or changes. IP-COM does not assume any liability that may occur due to the use or application of the product or circuit layout(s) described herein. Every effort has been made in the preparation of this document to ensure accuracy of the contents, but all statements, information and recommendations in this document do not constitute a warranty of any kind, express or implied.

Preface

Thank you for choosing IP-COM! This user guide helps you configure, manage and maintain the product.

Conventions

This user guide is applicable to the following switches. For product features and software screenshots, please refer to the actual product. G3326P-24-410W is used for illustration if there is no other specification.

Model	Product Name
G3310P-8-150W	8GE+2SFP Cloud Managed PoE Switch
G3318P-16-250W	16GE+2SFP Cloud Managed PoE Switch
G3326P-24-410W	24GE+2SFP Cloud Managed PoE Switch
G3310F	8GE+2SFP Cloud Managed Switch





Functions of different models may differ. Please refer to the actual web UI of the product.

The typographical elements that may be found in this document are defined as follows.

Item	Presentation	Example
Cascading menus	>	Choose System > Live Users .
Parameter and value	Bold	Set User Name to Tom .
Variable	<i>Italic</i>	Format: <i>XX:XX:XX:XX:XX:XX</i>
UI control	Bold	On the Policy page, click the OK button.

The symbols that may be found in this document are defined as follows.

Item	Meaning
 Note	This format is used to highlight information of importance or special interest. Ignoring this type of note may result in ineffective configurations, loss of data or damage to device.

Item	Meaning
 Tip	This format is used to highlight a procedure that will save time or resources.

For more documents

Go to our website at www.ip-com.com.cn and search for the latest documents for this product.

Product materials

Document	Description
Data sheet	It introduces the basic information of the device, including product overview, selling points, and specifications.
Quick installation guide	It introduces how to set up the device quickly for internet access, the descriptions of LED indicators, ports, and buttons, FAQ, statement information, and so on.
User guide	It introduces how to set up more functions of the device for more requirements, including all functions on the web UI of the device.

Technical support

If you need more help, contact us using any of the following means. We will be glad to assist you as soon as possible.



(86 755) 2765 3089



info@ip-com.com.cn



www.ip-com.com.cn

Revision history

IP-COM is constantly searching for ways to improve its products and documentation. The following table indicates any changes that might have been made since the user guide was released.

Version	Date	Description
V1.0	2021-11-18	Original publication

Contents

1 Web login	1
1.1 Login	1
1.2 Logout.....	3
2 Web UI introduction	4
2.1 Web layout.....	4
2.2 Commonly used buttons	5
3 System management	6
3.1 System info	6
3.2 User management	8
3.3 Restore to factory settings.....	9
3.3.1 Software reset.....	9
3.3.2 Hardware reset	9
3.4 Reboot	10
3.5 Firmware upgrade	11
4 Port management.....	12
4.1 Port configuration.....	12
4.2 Port mirroring	14
4.3 Port statistics	15
5 Link aggregation	16
6 Network extension	18
7 PoE management	19
8 VLAN management.....	21
8.1 Overview.....	21
8.2 Configure 802.1Q VLAN	22
8.2.1 Create VLAN rules	22
8.2.2 Configure VLAN port members	22
8.3 Example of 802.1Q VLAN configuration	24
9 Device management.....	27
9.1 MAC binding	27
9.1.1 Overview	27
9.1.2 Configure MAC binding	27
9.1.3 Example of configuring MAC binding.....	28
9.2 QoS	30

9.2.1 Overview	30
9.2.2 Configure QoS	31
9.3 STP	33
9.3.1 Overview	33
9.3.2 STP global settings	37
9.3.3 STP port configuration	39
9.4 Diagnosis.....	41
9.5 IMS cloud management	42
9.5.1 Overview	42
9.5.2 Management on IP-COM IMS Cloud.....	43
9.5.3 Management on IP-COM IMS app	44
10 Configuration	48
10.1 Back up system configurations	48
10.2 Import configuration file	48
Appendix.....	50
Acronyms and Abbreviations.....	50
Configure the switch to access the internet.....	51

1 Web login

1.1 Login

1. Connect the computer to one of the RJ45 ports of the switch using an Ethernet cable.
2. Set the IP address of Ethernet (or Local Area Connection) of the computer to an unused one belonging to the same network segment of the IP address of the switch.

For example, the default IP address of the switch is **10.16.16.168**, you can set the IP address of the computer to **10.16.16.X** (X is an unused number ranging from 2 to 254 except 168), and subnet mask to **255.255.255.0**.

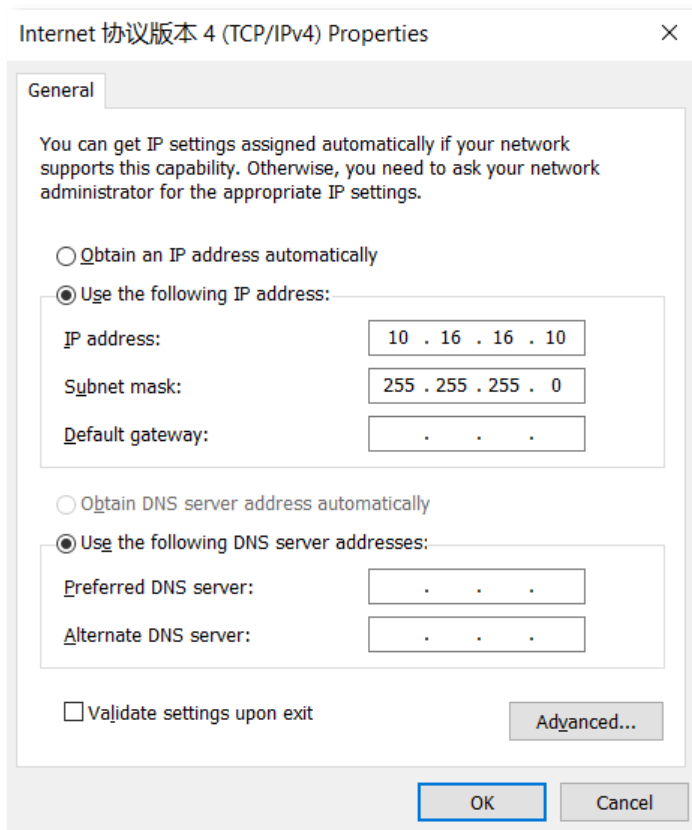

3. Start a browser (such as Chrome) and enter the IP address of the switch (default: **10.16.16.168**) in the address bar to access the login page.

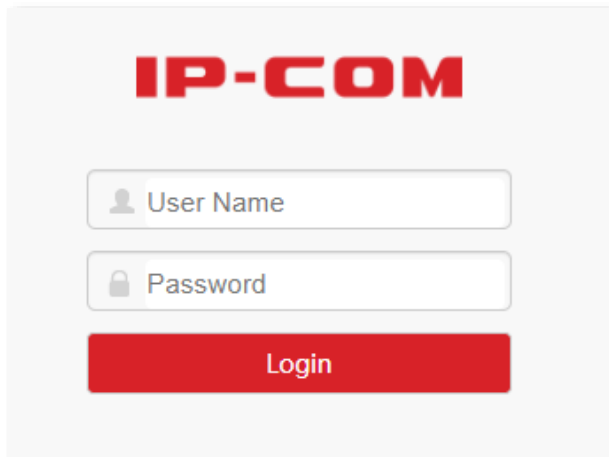

4. Enter your user name and password (both are **admin** by default) and click **Login**.

The image shows a login form for IP-COM. At the top, the text "IP-COM" is displayed in a bold, red, sans-serif font. Below this, there are two input fields: the first is labeled "User Name" with a small person icon to its left, and the second is labeled "Password" with a small lock icon to its left. Both fields are white with a light gray border. Below the input fields is a prominent red rectangular button with the word "Login" written in white, centered text.

----End



Tip

If the above page does not appear, try the following solutions:

- Clear the cache of the web browser or try another web browser.
- Check whether another device with the IP address 10.16.16.168 exists in the local network.
- If the problem persists, reset the switch and try again. Reset method: When the **SYS** LED indicator is blinking, press down the reset button (RESET) using a sharp item (such as a pin) for about 7 seconds, and then release it when all LED indicators are solid on. When the **SYS** LED indicator blinks again, the switch is reset successfully.

After logging in to the web UI, you can start to configure the switch.

1.2 Logout

After you log in to the switch's web UI page, the system will automatically log you out if there is no operation within five minutes. Alternatively, you can directly click **Logout** on the upper right corner to exit the web UI page.

2 Web UI introduction

2.1 Web layout







The Web UI page can be divided into four parts: level-1 navigation bar, level-2 navigation bar, tab page area, and the configuration area.

The screenshot shows the Web UI configuration page for STP. The page is divided into four numbered parts:

- 1** Level-1 navigation bar: A dark sidebar on the left containing menu items like System Management, Port Management, Link Aggregation, Network Extension, PoE Management, VLAN Management, Device Management (highlighted), MAC Binding, QoS, STP (highlighted), Diagnosis, IMS Cloud Management, and Configuration.
- 2** Level-2 navigation bar: A sub-menu within the sidebar, specifically 'STP'.
- 3** Tab page area: A horizontal bar at the top of the main content area with tabs for 'Global Settings' (active) and 'Port Configuration'.
- 4** Configuration area: The main content area displaying configuration options for 'Global Settings' (RSTP, System Priority, Hello Time, Maximum Aging Time, Forwarding Delay) and 'Root Bridge Status' (Bridge ID, Root Bridge ID, Hello Time, Maximum Aging Time, Forwarding Delay).

No.	Name	Description
1	Level-1 navigation bar	The navigation bars and tab pages display the function menu of the switch. When you select a function in navigation bar, the configuration of the function appears in the configuration area.
2	Level-2 navigation bar	
3	Tab page area	
4	Configuration area	This area enables you to view and modify configuration.
		 Tip Features and parameters in gray indicate that they are not available or cannot be changed under the current condition.

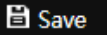
2.2 Commonly used buttons

Common buttons	Description
	Used for adding new rules on the current page.
	Used for deleting the rules on the current page.
	Used for selecting ports.
	Used for saving the configurations on the current page and enabling the configurations to take effect.
	 Note Used for saving the modified configurations of the current page temporarily. When the switch is suddenly powered off (for example, unplugging of switch), the configurations will be cleared after reboot.
	Used for saving all current configurations of the switch. When the switch is suddenly powered off, the configurations still remain after reboot.
	Used for viewing help information corresponding to the settings on the current page.

3 System management

3.1 System info

Click **System Management > System Info** to enter the page. On this page, you can view and modify basic parameters of the switch.

System Info	
Firmware Version	V64.22.14.7 (1218) build 2021-09-10 10:33:20
Hardware Version	V1.0
MAC Address	D838-0D03-0409
Management VLAN	1
Device Name	G3326P-24-410W
DHCP Client	Enable
IP Address	192.168.96.115
Subnet Mask	255.255.255.0
Gateway	192.168.96.1
Primary DNS	192.168.108.110
Secondary DNS	192.168.108.108
Aging Time	300 (60 to 3000 s)
IMS Cloud Management	Disconnected

Parameter description

Name	Description
Firmware Version	It displays the firmware version of the switch.
Hardware Version	It displays the hardware version of the switch.
MAC Address	It displays the MAC address of the switch.
Management VLAN	<p>When VLAN mode is 802.1Q VLAN, the management VLAN of the switch is 1 and cannot be modified.</p> <p> Note</p> <p>The switch can be visited only when the computer is connected to the VLAN port member (PVID of the port is 1).</p>

Name	Description
Device Name	It displays the name of the switch.
DHCP Client	Enable/Disable DHCP client function <ul style="list-style-type: none"> – Enable: The switch will automatically acquire IP address, subnet mask, gateway and DNS server address from the DHCP server. – Disable: Manual settings are required for IP address, subnet mask, gateway and DNS server address to manage the device and connect to Internet.
IP Address	The IP address of the switch. The default IP address is 10.16.16.168 and can be modified when DHCP client is disabled. Also, it is the management IP address of the switch which can be used to log in to the web UI.
Subnet Mask	The subnet mask of the IP address. The default subnet mask is 255.255.255.0, and can be modified when DHCP client is disabled.
Gateway	The gateway address of the switch by default. It can be modified when DHCP client is disabled.
Primary DNS	The primary/secondary DNS server address of the switch. It can be modified when DHCP client is disabled.
Secondary DNS	
Aging Time	The dynamic MAC aging time of the switch, which is 300s by default. <div style="text-align: center;">  Tip </div> <p>Short aging time will drive the dynamic MAC address table to refresh more frequently and destination addresses in the received data packages cannot be found. As a result, the switch is only capable of broadcasting these packages to all ports, at the price of damaging the switch performance.</p> <p>Long aging time will force the dynamic MAC address table to save up too many stale addresses until it uses up all address tables. Eventually, the switch fails to refresh them upon changing network.</p>
IMS Cloud Management	It displays whether the switch is connected to the IP-COM IMS cloud platform.

3.2 User management

Click **System Management** > **User Management** to enter the page. Here, you can change the login user name and password.

System Info **User Management** Restore to Factory Settings Reboot Firmware Upgrade help

User Configuration

User Name (1 to 15 characters, consisting of letters, digits and underscores, and it must start with a letter)

Old Password

New Password (8 to 15 characters, consisting of at least two kinds of characters among letters, digits, underscores and hyphens)

Confirm Password

When you click **Apply** to save the change, the switch will reboot automatically and redirect to the login page. Enter the new user name and password to log in to the web UI.

3.3 Restore to factory settings

If you cannot solve certain network issues, or you forget your user name or password when logging in to the web UI of the switch, you can restore the switch to factory settings, and then use the default user name and password (both are **admin**) to log in. This switch supports Software reset and Hardware reset.

3.3.1 Software reset

Click **System Management** > **Restore to Factory Settings** to enter the page.



To avoid any damages, please ensure stable power supply to the switch during the resetting process.

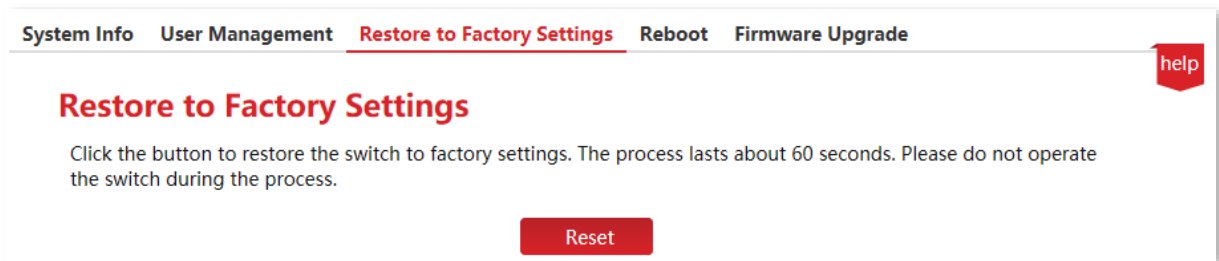

3.3.2 Hardware reset

When the **SYS** LED indicator is blinking, press down the reset button (**RESET**) using a sharp item (such as a pin) for about 7 seconds, and then release it when all indicators are solid on. When the **SYS** LED indicator blinks again, the switch is restored to factory settings.

3.4 Reboot

When a parameter you set does not work properly, you can try to reboot the switch to fix this issue.

Click **System Management** > **Reboot** to enter the page. On this page, you can click **Reboot** to restart the switch.



Please click **Save** on the upper right corner to save all settings before rebooting the switch.

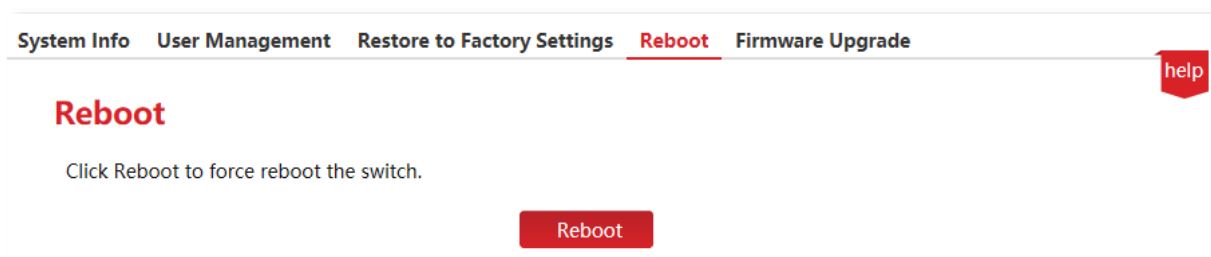

3.5 Firmware upgrade

Click **System Management** > **Firmware upgrade** to enter the page. On this page, you can upgrade firmware of the switch, getting better user experience.



To avoid damages to the switch, ensure that the switch is upgraded properly. Please note that:

- Before upgrading, you can download the latest firmware of the switch on the IP-COM official website: www.ip-com.com.cn. Generally, the filename extension of the upgrading file is **.bin**.
- During the upgrading process, ensure stable power supply to the switch.

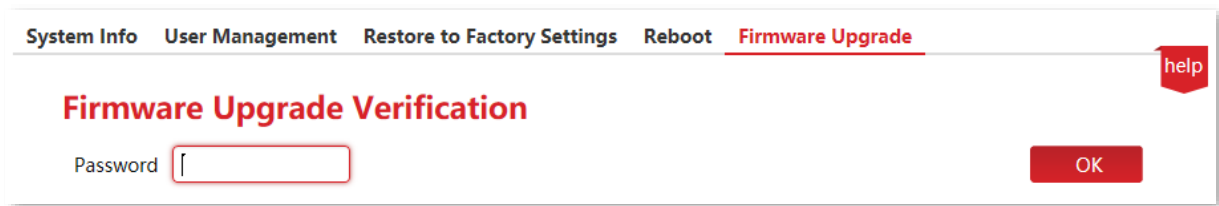

The screenshot shows a web interface with a navigation menu at the top containing 'System Info', 'User Management', 'Restore to Factory Settings', 'Reboot', and 'Firmware Upgrade'. The 'Firmware Upgrade' menu item is highlighted with a red underline. Below the menu is a dialog box titled 'Firmware Upgrade Verification' in red text. The dialog box contains a 'Password' label followed by a text input field with a red border. To the right of the input field is a red 'OK' button. In the top right corner of the dialog box, there is a red 'help' button.

The upgrade verification password is the login password of the web UI.

4 Port management

4.1 Port configuration

Click **Port Management > Port Configuration** to enter the page. On this page, you can view and configure the basic parameters of the ports.

Port	Link Status	Speed/Duplex	Priority	Flow Control	State	Storm Control	Address Learning
1	1000M_FDX	Auto	Low	Enable	Enable	Disable	Enable
2	---	Auto	Low	Enable	Enable	Disable	Enable
3	---	Auto	Low	Enable	Enable	Disable	Enable
4	---	Auto	Low	Enable	Enable	Disable	Enable
5	1000M_FDX	Auto	Low	Enable	Enable	Disable	Enable
6	---	Auto	Low	Enable	Enable	Disable	Enable

Parameter description

Name	Description
Port	It specifies the ID of the port.
Link Status	It specifies the current connection status and duplex mode of the port. “---” indicates that the port is not connected or not negotiated successfully.
Speed/Duplex	It specifies the negotiation speed and duplex mode of the port. <ul style="list-style-type: none"> – Auto (Auto-negotiation): The port automatically negotiates the speed and duplex mode with the peer device. – HDX: Half duplex mode. – FDX: Full duplex mode.
Priority	Select the port priority when setting QoS.
Flow Control	Enable/Disable the flow control function of the selected port. By default, the port flow control is enabled.

Name	Description
	<p>When the flow control of the switch and the terminal equipment are all enabled, if some port congestion of the switch occurs, the port will send the pause frame to the terminal equipment that will be suspended to send data after receiving the pause frame. Meanwhile, when one port of the switch receives a pause frame, the port also will be paused to send data.</p> <p> Note</p> <p>Enable the flow control to avoid the data packet loss caused by the inconsistency of the sending and receiving rate. Yet that will also affect the communication rate of the data source port and other facilities. Please be careful with this function when linking the network port.</p>
State	<p>Enable/Disable the forwarding function of the selected port.</p>
Storm Control	<p>Enable/Disable the broadcasting storm control function of the selected port. By default, the storm control is disabled.</p> <p>Broadcast storm means that the broadcasting frame quantities are soaring up due to the continuous transmissions, which brings negative effect on the communication, degrades the system performance and even results in breakdown of the network.</p> <p>While enabling the storm control, the switch will discard the excessive broadcasting messages as the broadcast traffic on the port exceeds the limited value (2000pps), thus reducing the proportion of the broadcast traffic to the limited range.</p>
Address Learning	<p>Enable/Disable the address learning function of the selected port.</p> <p>While enabling the address learning, if no corresponding MAC address in the MAC address table as the switch receives the data package, it will broadcast this package to all ports. The switch will record the corresponding MAC port to the MAC table when the destination host returns some information from one port.</p> <p>The MAC address table keeps the system port corresponding to the MAC address of the host linking with that port.</p>

4.2 Port mirroring

Port mirroring is a method of copying and sending data from a port or multiple ports (source ports) to a specified port (destination port) of the switch. The destination port is usually connected to a data monitoring device, enabling you to monitor data traffic, analyze performance and diagnose faults.

Click **Port Management > Port Mirroring** to enter the page. On this page, you can configure the port mirroring rules.

Source Port	Port Mirroring
1	<input type="checkbox"/>
2	<input type="checkbox"/>

Parameter description

Name	Description
Source Port	It specifies the ports whose packets will be copied. Multiple ports can be selected.
Destination Port	Packets of source ports will be copied to this port. A mirroring group can contain only one destination port.
Port Mirroring	Select the source port for port mirroring.
Mirroring Direction	<p>It specifies the packet type.</p> <ul style="list-style-type: none"> – Ingress: Packets received by source ports will be copied to the destination port. – Egress: Packets transmitted by source ports will be copied to the destination port. – Both (Two-way): Packets transmitted and received by source ports will be copied to the destination port.

4.3 Port statistics

Click **Port Management > Port Statistics** to enter the page. On this page, you can view and clear the packet statistics of each port.

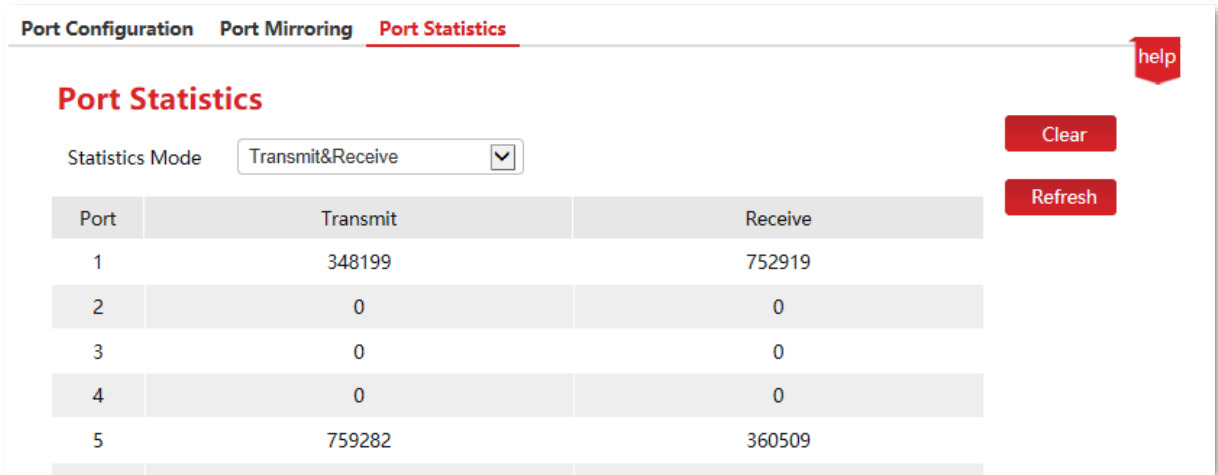

Port Configuration Port Mirroring **Port Statistics** help

Port Statistics

Statistics Mode: Transmit&Receive

Clear Refresh

Port	Transmit	Receive
1	348199	752919
2	0	0
3	0	0
4	0	0
5	759282	360509

Parameter description

Name	Description
Port	It specifies the ID of the port.
Statistics Mode	<p>It specifies the statistics mode of port packets.</p> <ul style="list-style-type: none"> – Transmit & Receive: It specifies the number of transmitted and received packets. – Conflict & Transmit: It specifies the number of collision packets and the number of transmitted packets. – CRC Error & Receive: It specifies the number of CRC verification error packets and received packets.
Clear	Clear port statistics of all ports.
Refresh	Refresh port statistics of all ports.

5 Link aggregation

Link aggregation is used to converge multiple physical ports into a logical aggregation group. Multiple physical links in one aggregation group are regarded as one logical link. The link aggregation function binds multiple physical links into one logic link and enables them to share traffic load for each other, thus increasing the bandwidth between the switch and the peer device. Meanwhile, each member in an aggregation group backs up each other's data dynamically, improving connection reliability.

The network topology of link aggregation is as shown below.

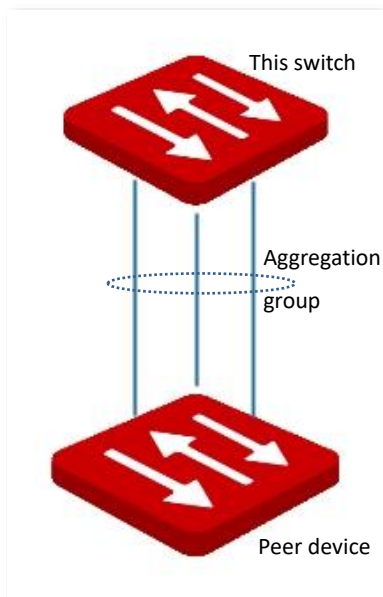

Note

In the same aggregation group, all member ports must be set to the same configurations with respect to STP, QoS, VLAN configuration and port management.

Click **Link Aggregation** to enter the page. On this page, you can configure the link aggregation rules.

Link Aggregation help

Aggregation Group ID	Member Ports				Enable
1	1 <input type="checkbox"/>	2 <input type="checkbox"/>	3 <input type="checkbox"/>	4 <input type="checkbox"/>	<input type="checkbox"/>
2	5 <input type="checkbox"/>	6 <input type="checkbox"/>	7 <input type="checkbox"/>	8 <input type="checkbox"/>	<input type="checkbox"/>
3	23/SFP1 <input type="checkbox"/>	24/SFP2 <input type="checkbox"/>			<input type="checkbox"/>

Apply

Parameter description

Name	Description
Aggregation Group ID	It specifies the ID of aggregation groups.
Member Ports	<p>Select the members of an aggregation group.</p> <p>The switch only supports static aggregation. In the static aggregation mode, all member ports in the aggregation group converge into one logical port.</p> <p> Note</p> <p>The aggregation mode of the switch needs to be the same as that of the peer device. Otherwise, the data cannot be forwarded properly or the loops occur.</p>
Enable	Enable the aggregation group.

6 Network extension



This section only applies to the switches G3310P-8-150W, G3318P-16-250W and G3326P-24-410W.

The switch offers you the network extension function, which can extend the data transmission and PoE Power Distance of downlink ports to make network deployment more convenient.

Once network extension is enabled, the port link speed will be automatically negotiated to 10Mbps. In this situation, if using the CAT5, CAT5E cable or better, the data transmission and PoE power distance can break 100 meters and reach 250 meters.

It is recommended to enable the function when multiple IP cameras are connected to the switch with long distance.

Click **Network Extension** to enter the page.

Network Extension
help

Network Extension

Network Extension: Enable ▼ Apply

<input type="checkbox"/>	Port	Network Extension	Link Status
<input type="checkbox"/>	1	Disable	1000M_FDX
<input type="checkbox"/>	2	Disable	---
<input type="checkbox"/>	3	Disable	---
<input type="checkbox"/>	4	Disable	---
<input type="checkbox"/>	5	Disable	1000M_FDX

Parameter description

Name	Description
Network Extension	Enable/Disable network extension of the selected port.
Port	It displays the number of the port which can supply PoE power.
Link Status	It displays the speed and duplex mode of the port. If not connected or negotiated failure, it will be shown as “---”.

7 PoE management



This section only applies to the switches G3310P-8-150W, G3318P-16-250W and G3326P-24-410W.

All downlink ports support PoE power supply and conform to IEEE 802.3af and IEEE 802.3at. The switch will automatically supply required PoE power to the powered device which is connected to the PoE port.

Click **PoE Management** to enter the page. You can check the PoE power status of the current switch and enable/disable the PoE power function of the downlink port as well.

Global Settings help

PoE Port Configuration

PoE Consumption Power: 0.00W Apply

PoE Remaining Power: 370.00W

PoE Status

No Change ▼

	Port	PoE Status	Supplied Power [W]
<input type="checkbox"/>	1	Enable	0.00
<input type="checkbox"/>	2	Enable	0.00
<input type="checkbox"/>	3	Enable	0.00
<input type="checkbox"/>	4	Enable	0.00

Parameter description

Name	Description
PoE Status	Enable/Disable the PoE power function of the selected port.
Port	It displays the downlink port number of the switch.
Supplied Power [W]	It displays the output power of the downlink port supplied by PoE.

Name	Description
PoE Consumption Power	It displays the total output power of the switch supplied by PoE.
PoE Remaining Power	It displays the remaining output power of the switch supplied by PoE.

8 VLAN management

8.1 Overview

VLAN (Virtual Local Area Network) is a technology that divides devices in LAN into different logical, instead of physical, network segments to form virtual working groups. VLANs allow a network station constituted by switches to be logically segmented into different domains for broadcast isolation. All members in a VLAN are treated as in the same broadcast domain and communicate as if they were on the same network segment, regardless of their physical locations. Different VLANs cannot intercommunicate directly. Inter-VLAN communication can only be achieved using a router or other layer-3 devices that are able to perform layer-3 forwarding.

The switch supports 802.1Q VLAN and can communicate with devices that support 802.1Q VLAN in VLAN as well.

As defined by IEEE 802.1q protocol, one 4 bytes 802.1Q VLAN tag is bound to be wrapped behind the destination MAC address and the source MAC address of the Ethernet frame for identifying the relevant information of VLAN. As shown below, the Ethernet frame with 802.1Q tag is produced by adding an 802.1Q VLAN tag behind the destination MAC address and the source MAC address of the standard Ethernet frame.

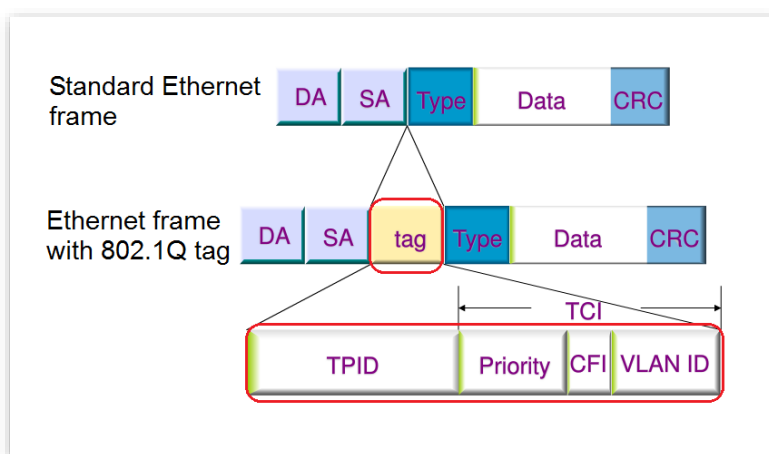

8.2 Configure 802.1Q VLAN

8.2.1 Create VLAN rules

A VLAN rule is created by default to ensure communication between switches in factory settings. All ports are set to be members of this VLAN by default with the VLAN ID of 1 and the IP address of 10.16.16.168. This rule cannot be deleted.

Click **VLAN Management** > **Create VLAN** to enter the page. On this page, you can configure the rules of 802.1Q VLAN.

Select	VLAN ID	VLAN Description
<input type="checkbox"/>	<input type="text"/>	<input type="text"/>
<input type="checkbox"/>	1	default
<input type="checkbox"/>	2	
<input type="checkbox"/>	3	
<input type="checkbox"/>	4	

4 in total

Parameter description

Name	Description
VLAN ID	It specifies the VLAN ID, used for identifying the VLAN to which the packet belongs. The management VLAN ID is 1 and cannot be deleted.
VLAN Description	It is used to identify VLAN.
Add	It is used to add VLAN.
Delete	It is used to delete VLAN.

8.2.2 Configure VLAN port members

Click **VLAN Management** > **802.1Q VLAN** to enter the page. On this page, you can configure the PVID and Tag treatment policies of each port to realize VLAN isolation.

Create VLAN **802.1Q VLAN** help

802.1Q VLAN

Select	Port	PVID	Tagged	Untagged	Edit
<input type="checkbox"/>					
<input type="checkbox"/>	1	1	--	1	
<input type="checkbox"/>	2	1	--	1	
<input type="checkbox"/>	3	1	--	1	
<input type="checkbox"/>	4	1	--	1	
<input type="checkbox"/>	5	1	--	1	

Parameter description

Name	Description
Port	It specifies the ID of the port.
PVID	It specifies the VLAN ID of a port, which is 1 by default. When receiving untagged packets, the port forwards them to the corresponding VLAN based on the PVID of the port itself.
Tagged	If the VLAN ID of the tagged packets received by the port is the same with the tagged VLAN, the port retains the tags of the packets and transmit them.
Untagged	If the VLAN ID of the tagged packets received by the port is the same with the untagged VLAN, the port removes the tags of the packets and transmit them.

8.3 Example of 802.1Q VLAN configuration

Networking requirement

The staff in the financial department and marketing department of a company work on the second floor, while the servers for these two departments are on the third floor. Now it is required that the communication is available within each department and the servers can be accessible respectively, but the two departments cannot communicate with each other.

Solution

Configure 802.1Q VLAN for two switches:

- Create two VLANs for the switches. Assign the ports connected to the financial department's devices to VLAN 5, and the ports to the marketing department's devices to VLAN 7.
- Add the ports that connect two switches to both VLAN 5 and VLAN 7.

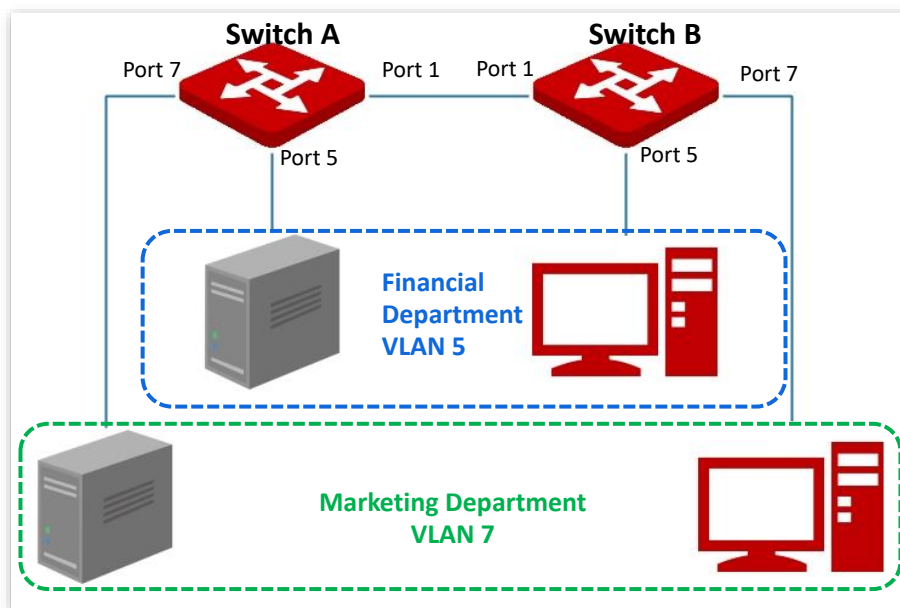

Configuration procedure

I. Configure Switch A

1. Create VLANs.
 - (1) Log in to the web UI of Switch A and click **VLAN Management > Create VLAN**.
 - (2) Enter the **VLAN ID** and **VLAN Description** and click **+Add**.

- Set **VLAN ID** to **5**.
 - Set **VLAN Description** to **Finance**.
- (3) Repeat step (2) and add another VLAN with the **VLAN ID** of **7** and **VLAN Description** of **Marketing**.

Create VLAN 802.1Q VLAN help

Create VLAN

Select	VLAN ID	VLAN Description	
<input type="checkbox"/>	<input type="text"/>	<input type="text"/>	+Add
<input type="checkbox"/>	1	default	-Delete
<input type="checkbox"/>	5	Finance	
<input type="checkbox"/>	7	Marketing	

3 in total

2. Configure port attribute.

- (1) Click **VLAN Management > 802.1Q VLAN**.
- (2) Select port 5, set its **PVID** to **5**, **Untagged** to **5**, and click **Edit**.
- (3) Select port 7, set its **PVID** to **7**, **Untagged** to **7**, and click **Edit**.
- (4) Select port 1, set **Tagged** to **1,5,7**, and click **Edit**.

Create VLAN 802.1Q VLAN help

802.1Q VLAN

Select	Port	PVID	Tagged	Untagged	
<input type="checkbox"/>	<input type="text"/>	<input type="text"/>	<input type="text"/>	<input type="text"/>	Edit
<input type="checkbox"/>	1	1	1,5,7	--	
<input type="checkbox"/>	2	1	--	1	
<input type="checkbox"/>	3	1	--	1	
<input type="checkbox"/>	4	1	--	1	
<input type="checkbox"/>	5	5	--	5	
<input type="checkbox"/>	6	1	--	1	
<input type="checkbox"/>	7	7	--	7	

II. Configure Switch B

Refer to the steps of configuring Switch A.

----End

Verification

The staff can access the server of their department, but cannot access the server of the other department. The staff in the same department can communicate with each other but cannot communicate to the staff of other departments.

9 Device management

9.1 MAC binding

9.1.1 Overview

MAC binding provides the function of static MAC address table: After a port is bound with a MAC address, the device that matches the designated MAC address can access the network only through this port, not through other ports.

The MAC binding function ensures network security and user authority and effectively prevents unauthorized users from gaining data by cheating and performing loiter net.



Bound MAC addresses are manually added and deleted, and will not be aged over time.

9.1.2 Configure MAC binding

Click **Device Management > MAC Binding** to enter the page. On this page, you can perform static MAC address binding.

MAC Binding
help

Static MAC Binding

Select Port	MAC Address 1	VLAN ID_1	MAC Address 2	VLAN ID_2	MAC Address 3	VLAN ID_3	
<input type="text" value="1"/>	<input type="text"/>	<input type="text"/>	<input type="text"/>	<input type="text"/>	<input type="text"/>	<input type="text"/>	<input type="button" value="Apply"/>

Port	Bound Static MAC Address					
	Bound MAC Address 1	VLAN ID_1	Bound MAC Address 2	VLAN ID_2	Bound MAC Address 3	VLAN ID_3
1	--	--	--	--	--	--
2	--	--	--	--	--	--
3	--	--	--	--	--	--
4	--	--	--	--	--	--

Parameter description

Name	Description
Select Port	Select a port whose static MAC address binding function needs to be configured.
MAC Address 1/2/3	<p>Enter an access device MAC address bound to this port. The switch supports binding up to three access devices.</p> <p> Note Broadcast or multicast address binding is not allowed.</p>
VLAN ID_1/2/3	It specifies the VLAN to which the MAC address belongs.
Bound MAC Address 1/2/3	It displays the bound MAC address.

9.1.3 Example of configuring MAC binding

Networking requirement

The MAC address of the user device is 94:C6:91:29:C2:C4. Connect it to port 3 of the switch to prevent other unauthorized users from performing loiter net or MAC addresses pretending to be the authorized user from gaining data from other ports of the switch.

Solution

Bind the MAC address of the user device to port 3 of the switch.

Assume that the user device belongs to VLAN 1.

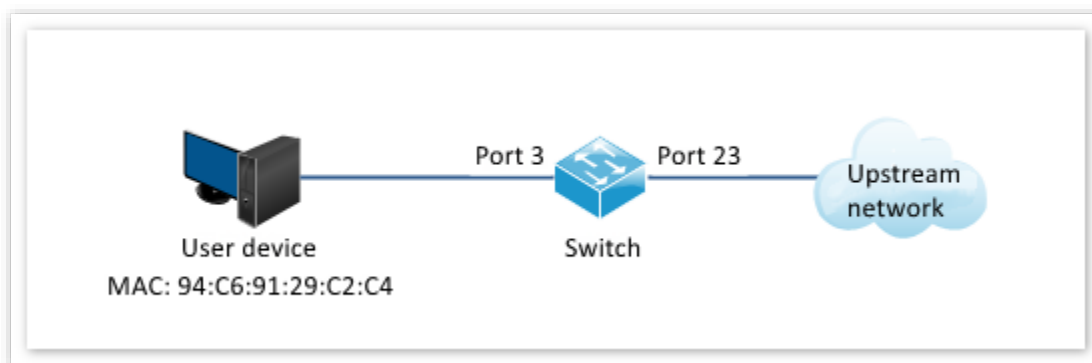

Configuration procedure

1. Log in to the web UI of the switch and click **Device Management > MAC Binding**.
2. Click the **Select Port** drop-down menu and select **3**.
3. Enter the user device MAC address **94C69129C2C4** in the **MAC Address 1** column, and set **VLAN ID_1** to **1**.
4. Click **Apply**.

MAC Binding help

Static MAC Binding

Select Port	MAC Address 1	VLAN ID_1	MAC Address 2	VLAN ID_2	MAC Address 3	VLAN ID_3	Apply
3	94c69129c2c4	1					

Port	Bound Static MAC Address					
	Bound MAC Address 1	VLAN ID_1	Bound MAC Address 2	VLAN ID_2	Bound MAC Address 3	VLAN ID_3
1	--	--	--	--	--	--
2	--	--	--	--	--	--
3	--	--	--	--	--	--

----End

MAC address is bound successfully. See the following figure.

MAC Binding help

Static MAC Binding

Select Port	MAC Address 1	VLAN ID_1	MAC Address 2	VLAN ID_2	MAC Address 3	VLAN ID_3	Apply

Port	Bound Static MAC Address					
	Bound MAC Address 1	VLAN ID_1	Bound MAC Address 2	VLAN ID_2	Bound MAC Address 3	VLAN ID_3
1	--	--	--	--	--	--
2	--	--	--	--	--	--
3	94:c6:91:29:c2:c4	1	--	--	--	--

Verification

The device with MAC address **94:C6:91:29:C2:C4** must be connected to port 3 of the switch to access the higher-level network. If the device with MAC address **94:C6:91:29:C2:C4** is connected to other ports of the switch, this device cannot access the higher-level network.

9.2 QoS



This section only applies to the switches G3310P-8-150W, G3318P-16-250W and G3326P-24-410W.

9.2.1 Overview

In traditional IP network, packets are treated equally. This network service policy is known as Best-Effort, which delivers the packets to their destinations with the best effort, with no assurance and guarantee for delivery delay, reliability, and so on. Nowadays, in addition to traditional applications such as www, FTP and E-mail, new services occur, such as video conference, remote education, Video-on-Demand (VoD) and video telephone, which need higher requirements for bandwidth, delay and jitter. QoS (Quality of Service) policy can meet the above demands and improve the quality of service in the network.

This switch classifies the messages according to priority at the ingress stage, then maps them to different queues at the egress stage, and finally forwards these messages by queues according to the scheduling mode, so as to guarantee the quality of network service.

Scheduling mode

This switch provides the simple QoS function. By setting a port priority, the system first discards packets on low-priority ports during network congestion to ensure transmission of packets on high-priority ports. The switch has a total of two priority queues. Queue Low is of low priority. Queue High is of high priority. The scheduling algorithms supported by the switch are First in First out (FIFO), Strict Priority (SP), and Weighted Round Robin (WRR). By default, the scheduling algorithm is FIFO.

Queue scheduling algorithms

- **First in First out (FIFO)**

FIFO is that packets that are received first are forwarded first. It applies to most network applications such as email and FTP.

- **Strict Priority (SP)**

Strict priority scheduling algorithm is specially designed for critical service applications. An important feature of critical services is that they demand preferential service in congestion in order to reduce the response delay.

In queue scheduling, the messages are sent in queues strictly following the priority order from high to low. When the queue with higher priority is empty, messages in the queue with lower priority are sent. You can put critical service messages into the queues with higher priority and put non-critical service messages (such as E-mail) into the queues with lower priority. In this

way, critical service messages are sent preferentially, and non-critical service messages are sent when the critical service messages are not sent.

Disadvantage of Strict Priority: If there are messages in the queues with higher priority for a long time during congestion, the messages in the queues with lower priority will keep stuck because they are not served.

■ **Weighted Round Robin Mode (WRR)**

In this mode, packets in all the queues are sent in order based on the weight value for each queue and every queue can be assured of a certain service time. Assuming there are 2 egress queues on the port. The two weight values (namely, w_2 and w_1) indicate the proportion of resources assigned to the two queues respectively. On a 100M port, if you set the weight values of WRR queue-scheduling algorithm to 7 and 3 (correspond to w_2 and w_1 respectively). Then the queue with the lowest priority can be ensured of, at least, 30 Mbps bandwidth, thus WRR queue overcomes the disadvantage of SP queue that the packets in the queues with lower priority cannot get service for a long time.

In WRR mode, though the queues are scheduled in order, the service time for each queue is not fixed, that is to say, if a queue is empty, the next queue will be scheduled. In this way, the bandwidth resources are made full use of.

Egress Discard

Messages are discarded on the egress port when congestion occurs in order to reduce the loading of the ingress port.

This is applicable to following special scenarios: Both 100 Mbps ports and 1000 Mbps ports exist when multicast packets are transmitted; perform RFC2889 test. This function is not recommended in common scenarios.

9.2.2 Configure QoS

1. Configure QoS mode.

- (1) Click **Device Management > QoS**.
- (2) Select a priority mode from the **QoS Mode** drop-down menu. If **WRR** is selected, you must also set **Low weight** and **High weight**. Note that the proportion of High must be greater than that of Low. This series of switches support a proportion of 1-7.

QoS help

QoS Mode

FIFO (First in First out)
 SP (Strict Priority)
 WRR (Weighted Round Robin)

Apply

Egress Discard

Disable ▼

(3) Click **Apply**.

2. Set port priority.

(1) Click **Port Management > Port Configuration**.

(2) Select a port (port 1 and port 2 in this example) and set the **Priority** (High or Low).

(3) Click **Apply**.

Port Configuration Port Mirroring Port Statistics help

Port Configuration

Enable/Disable No Change ▼ Speed/Duplex No Change ▼ **Apply**

Priority No Change ▼ Flow Control No Change ▼

Storm Control No Change ▼ Address Learning No Change ▼

<input type="checkbox"/>	Port	Link Status	Speed/Duplex	Priority	Flow Control	State	Storm Control	Address Learning
<input type="checkbox"/>	1	---	Auto	High	Enable	Enable	Disable	Enable
<input type="checkbox"/>	2	1000M_FDX	Auto	Low	Disable	Enable	Disable	Enable
<input type="checkbox"/>	3	1000M_FDX	Auto	Low	Enable	Enable	Disable	Enable

----End



- Priority for all ports should be set to Low when FIFO mode is used.
- If the QoS mode is SP, set Port 1 to High and Port 2 to Low in Priority. When both ports send packets to the same port at the same time, this port will let packets from Port 1 pass, followed by packets from Port 2.
- If WRR is selected, set weights to High=7 and Low=1 respectively. When both ports send packets to the same port at the same time, this port will send packets in a traffic proportion of 7:1.

9.3 STP

9.3.1 Overview

Spanning Tree helps avoid loops in the network to protect the network from broadcast storms, and provide link redundancy backup.

STP is a network protocol based on IEEE 802.1d. It is a protocol that ensures a loop-free topology for local area network and provides backup redundant links. The devices under this protocol discover the loops in the network by communicating with each other, and selectively block some ports, and eventually establish a spanning tree structure without loops, so as to prevent the decline of the message processing capacity of the devices due to the continuous proliferation and endless circulation of messages in the loop network.

STP protocol message

To implement spanning tree function, switches in the network transfer BPDUs (Bridge Protocol Data Unit) between each other to exchange information. BPDUs carry the information that is needed for switches to calculate the spanning tree.

The network topology is determined by BPDU transmission among devices. There are two types of BPDUs of STP protocol:

- Configuration BPDU: It is used for spanning tree calculation and spanning tree topology maintenance.
- TCN BPDU (Topology Change Notification BPDU): It is used to notify the changes of the network topology structure.

Basic concepts of STP

■ Bridge ID

The bridge ID contains both bridge priority and MAC address, in which the bridge priority is a configurable parameter. The smaller the bridge ID, the higher the bridge priority. The root bridge is the bridge with the smallest bridge ID.

■ Root bridge

Root bridge acts as the root of a tree. There is only one root bridge in the network and it is changeable according to the network topology changes.

Initially, all devices regard themselves as the root bridges. They generate their own configuration BPDUs and send them out periodically. When the network topology becomes stable, only the root bridge device can send configuration BPDUs out and other devices can only forward these BPDUs.

■ Root port

The root port is the port in a non-root bridge device that has the smallest path cost from the bridge to the root bridge, responsible for communication with the root bridge. There is only one root port on the non-root bridge device and no root port on the root bridge device.

■ Designated bridge and designated port

- Designated bridge: For a switch, designated bridge is the device that connects to and forwards BPDUs to the switch. For the LAN, it is the device that forwards BPDUs in the same network segment.
In each network segment, the device with the least path cost to the root bridge is the designated bridge. If more than one switch has the same path cost to the root bridge, the one with the smallest bridge ID is the designated bridge.
- Designated port: As for a device, the designated port is the port that forwards BPDUs to the host. As for a LAN, it is the port that forwards BPDUs in the same network segment.

■ Path cost

It is a parameter for choosing the link path by STP. By calculating the path cost, STP chooses the better links and blocks the redundant links, so as to disbranch the loop-network to form a tree-topological loop-free network.

The basic network diagram of STP is shown as the following figure. The switch A, B and C are connected successively.

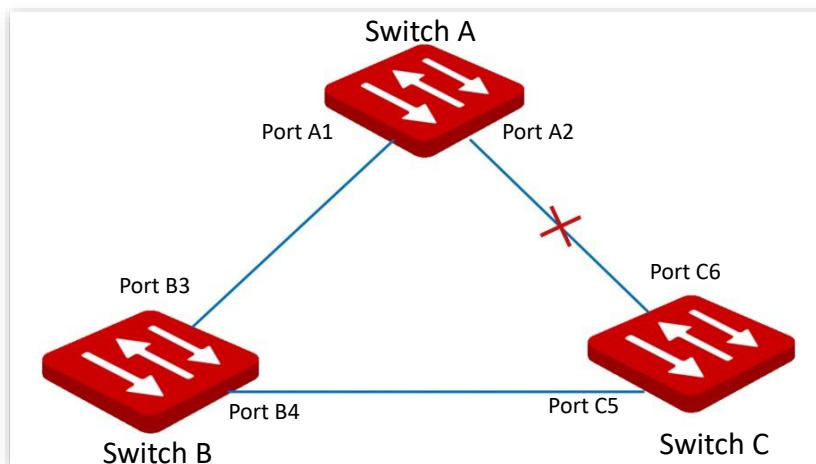

After calculation, switch A is selected as the root bridge, and the link between ports A2 and C6 is blocked.

- Bridges: Switch A is the root bridge of the network, while switch B is the designated bridge of switch C.
- Ports: Port B3 and port C5 are the root ports of switch B and switch C respectively. Port A1 and port B4 are the designated ports of switch A and switch B respectively. Port C6 is the blocking port of switch C.

BPDU priority in STP mode

The smaller the bridge ID is, the higher the bridge priority is. If the root bridge ID is the same, then the root path costs are compared. The comparison method is to assume the root path cost in BPDU and the path cost corresponding to this port to be S , then the BPDU with smaller S has higher priority.

If the root path costs are the same, compare the designated bridge ID, designated port ID and ID of the port that receives the BPDU successively, one with the smallest ID has higher priority.

STP computing process

1. Initial status

Initially, each port of the switch generates a BPDU regarding the switch as the root bridge, with the root path cost being 0, the ID of the designated bridge being the switch ID, and the designated port being itself.

2. Optimal BPDU selection

Each switch sends out its BPDUs and receives BPDUs from other switches. The following table shows the procedure to select the optimal BPDU.

Step	Content
1	<p>Receiving BPDU with lower priority: If the priority of the BPDU received by a port is lower than that of the port itself, the switch discards the received BPDU and does not deal with the BPDU of that port.</p> <p>Receiving BPDU with higher priority: If the priority of the received BPDU is higher than that of the port itself, the switch replaces the BPDU of the port with the received one.</p>
2	The switch selects the best BPDU by comparing BPDUs on all ports.

3. Root bridge selection

The root bridge is selected by BPDU exchange and root bridge ID comparison. The switch with the smallest root bridge ID is chosen as the root bridge.

4. Root port and designated port selection

The selection procedure is shown in the following table.

Step	Content
1	For each switch (except the root bridge), the port that receives the optimal BPDU is chosen as the root port of the switch.
2	<p>The switch calculates a designated port BPDU for each port according to the root port BPDU and root port path cost.</p> <ul style="list-style-type: none"> The ID of the root bridge is replaced with that of the root port.

Step	Content
	<ul style="list-style-type: none"> – Root path cost is replaced with the sum of the root path cost of the root port BPDU and the path cost corresponding the root port. – The ID of the designated bridge is replaced with that of the switch itself. – The ID of the designated port is replaced with the port ID itself.
3	<p>The switch compares the calculated BPDU with the BPDU of the port whose role requires to be determined, and deals with the port according to different comparison results.</p> <ul style="list-style-type: none"> – If the calculated BPDU takes the precedence over the BPDU of the port, the port is chosen as the designated port with its BPDU replaced with the calculated BPDU, and regularly sends out the BPDU. – If the BPDU of this port takes the precedence over the calculated BPDU, the BPDU of this port is not changed and the port is blocked. The port only receives BPDUs but cannot forward BPDU or other data.



In a stable topology, only the root ports and designated ports can forward data, and other ports are blocked. The blocked ports can only receive BPDUs, but not forward data.

STP Timer

■ Hello Time

It specifies the interval for the root bridge to send BPDU messages to other switches, used to test if the links malfunction.

■ Maximum Aging Time

It specifies the maximum duration during which if a switch does not receive a BPDU message from the root bridge, it sends BPDU packets to all the other switches for recalculating the new STP.

■ Forwarding Delay

It specifies the delay time the port state migration takes after the network topology changes.

Link malfunction leads to STP recalculation in the network, in which case, the STP structure will change accordingly. However, as the new BPDUs cannot be spread to the whole network immediately, the temporal loops might occur if the new root ports and the designated ports forward data at once. Therefore, STP adopts a state migration mechanism, that is, the new root ports and designated ports begin to forward data after twice forwarding delay, which ensures the new BPDUs have been spread to the whole network.

RSTP

RSTP is defined by the IEEE 802.1w standard and downward compatible with IEEE 802.1d STP. In addition to a loop-free network and redundant links, it features with fast convergence. If all bridges in a LAN support RSTP, it enables a rapid topology tree generation when the network topology changes (traditional STP topology tree: 50 seconds, RSTP topology tree: 1 second).

RSTP determines the network topology by exchanging BPDUs among switches. However, the BPDU format of RSTP differs from that of STP. When the topology is changing, RST-BPDU messages are spread by floods to notify the change to the whole network.

Conditions for rapid state migration of the root ports and designated ports in RSTP:

- Root port: The original root port of the switch stops forwarding data and the designated port of the upstream switch begins to forward data.
- Designated port: If the designated port is an edge port, it can directly transit to forwarding state; if the designated port is a P2P port, it can transit to forwarding state once it gets response from the downstream switch through handshake.

■ Edge Port

An edge port is a designated port on the edge of the switching network. It is directly connected to terminal devices. An edge port can transit to forwarding state immediately without going through listening and learning states. If it receives a BPDU, it immediately turns from an edge port to a common spanning tree port, and joins the STP generation.

■ P2P Port

A P2P port used to connect to other switches. Under RSTP/MSTP, all ports operating in full-duplex mode are P2P ports.

9.3.2 STP global settings

Click **Device Management > STP > Global Settings** to enter the page.

The screenshot displays the 'Global Settings' configuration page for STP. The page is titled 'Global Settings' and 'Port Configuration'. It includes a 'help' icon in the top right corner and an 'Apply' button. The settings are as follows:

Setting	Value	Range
RSTP	Disable	
System Priority	32768	
Hello Time	2	(1 to 10 s)
Maximum Aging Time	20	(6 to 40 s)
Forwarding Delay	15	(4 to 30 s)

Root Bridge Status	
Bridge ID	32768: D838-0D03-0409
Root Bridge ID	32768: D838-0D03-0409
Hello Time	2
Maximum Aging Time	20
Forwarding Delay	15

Global settings

It is used to configure and view the global properties of spanning tree functions of the switch.

Global Settings

RSTP	<input type="text" value="Disable"/>	▼
System Priority	<input type="text" value="32768"/>	▼
Hello Time	<input type="text" value="2"/>	(1 to 10 s)
Maximum Aging Time	<input type="text" value="20"/>	(6 to 40 s)
Forwarding Delay	<input type="text" value="15"/>	(4 to 30 s)

Parameter description

Name	Description
RSTP	Enable/Disable RSTP function of the switch.
System Priority	Set the priority of the switch. Priority is an important reference to determine whether the switch will be selected to work as root bridge, and switch with higher priority will be selected to work as root bridge under equivalent conditions. The lower the value, the higher the priority. Priority is 32768 by default.
Hello Time	It specifies the interval at which the switch sends BPDU, which is set to 2 seconds by default.
Maximum Aging Time	It specifies the maximum duration during which the BPDU can be kept in the switch. The configuration should meet the following formulas: <ul style="list-style-type: none"> - Maximum Aging Time $\geq 2 \times (\text{Hello Time} + 1)$ - Maximum Aging Time $\leq 2 \times (\text{Forwarding Delay} - 1)$
Forwarding Delay	It specifies the delay that the port state migration takes after the network topology changes, which is set to 15 seconds by default.

Root bridge status

Root Bridge Status

Bridge ID	32768: D838-0D03-0409
Root Bridge ID	32768: D838-0D03-0409
Hello Time	2
Maximum Aging Time	20
Forwarding Delay	15

Parameter description

Name	Description
Bridge ID	It displays the bridge ID of current switch which is comprised of the system priority and MAC address of the switch.
Root Bridge ID	In the entire network spanning tree, it is selected to serve as a bridge ID of root bridge device.
Hello Time	It displays the Hello Time value of Root bridge setting.
Maximum Aging Time	It displays the value of maximum aging time of root bridge setting.
Forwarding Delay	It displays the value of forwarding delay of root bridge setting.

9.3.3 STP port configuration

Click **Device Management > STP > Port Configuration** to enter the page. On this page, you can configure the STP parameters of the ports.

Port	Role	Status	Link Status	Path Cost	Priority
1	--	Disabled	--	20000	128
2	--	Disabled	1000M_FDX	20000	128
3	--	Disabled	1000M_FDX	20000	128

Parameter description

Name	Description
Select Port	Select the port to be set.
Priority	Set the port priority, effective values are integral multiples of 16, and the lower the value, the higher the priority. Port priority is an important reference to determine whether the ports connected to port will be selected to work as root ports. Ports on downstream device connected to a port with a higher priority will be selected to work as root port under equivalent conditions.
Path Cost (0=AUTO)	Set the path cost of port.
Role	It displays the role of port: Root, Designated, Alternate, Backup and --. "--" indicates that the port is not connected or that the STP function of switch is

Name	Description
	disabled.
Status	It displays the status of the port: Forwarding, Learning, Listening, Blocking, Discard and Disabled.
Link Status	It displays the rate and duplexing mode of the port. "--" indicates that the port is not connected or negotiation fails.

9.4 Diagnosis

Click **Device Management > Diagnosis** to enter the page. On this page, you can perform Ping test to test network connection and connection quality.

Ping Test

Target IP Address	<input type="text"/>	(Enter the IP address or domain name)	Start
Transmit Times	<input type="text" value="5"/>	(Range: 1 to 100)	
Packet Size	<input type="text" value="64"/>	(Range: 18 to 512)	

Parameter description

Name	Description
Target IP Address	It specifies the IP address or domain name of the destination device to be pinged.
Transmit Times	It specifies the number of data packets sent by Ping.
Packet Size	It specifies the size of data packets sent by Ping.

9.5 IMS cloud management

9.5.1 Overview

IP-COM IMS Business Cloud Platform is a cloud platform established by IP-COM, providing central management for IP-COM devices that support IMS cloud management.

With this switch managed by the IMS cloud platform, you can configure and check the parameters of the switch on the IMS cloud platform. You can also configure and check these parameters on the web UI of the switch.

To enable IMS Cloud Management function of the switch, click **Device Management > IMS Cloud Management** to enter the page.



- Please ensure that the switch can access the internet, otherwise it cannot be managed by the IMS cloud platform.
- With the switch managed by the IMS cloud platform, you can modify the parameters of the switch on both the IMS cloud platform or web UI of the switch. The parameters of the switch take effect based on the last modification.

IMS Cloud Management

IMS Cloud Management

IMS Cloud Management

Unique Cloud Code

Unique Cloud Code is used to associate the device to your IMS Cloud account. You can obtain this code either on IMS Cloud (<https://imsen.ip-com.com.cn>) or from the Account Center of the IP-COM IMS app.

Report

Note: If disabled, the device can neither be managed nor maintained by IMS Cloud.

Parameter description

Name	Description
IMS Cloud Management	It is used to enable or disable the IMS Cloud Management function.
Unique Cloud Code	It is used to associate the device with your IP-COM IMS Business Cloud Platform account. Methods to obtain this code:

Name	Description
	<ul style="list-style-type: none"> – IMS cloud platform: Log in to the IP-COM IMS Business Cloud Platform, click your account name on the upper right corner, and you can find Unique Cloud Code on the drop-down list. – IMS app: Find it in the Account Center of the IP-COM IMS app.
Report	Only with this function enabled, the switch can be managed by the IMS cloud platform, and its configuration can be reported to the IMS cloud platform.

9.5.2 Management on IP-COM IMS Cloud



- Before configuring the IMS Cloud Management function, please ensure that the switch has connected to the internet.
- Refer to [Configure the switch to access the internet](#) if necessary.

1. Log in to IP-COM IMS Cloud and obtain Unique Cloud Code.

- (1) Start a web browser, visit <https://imsen.ip-com.com.cn>, and log in to IP-COM IMS Cloud.
- (2) Click the personal avatar at the upper right corner and select **Unique Cloud Code**.
- (3) Click **Copy** to copy the Unique Cloud Code.

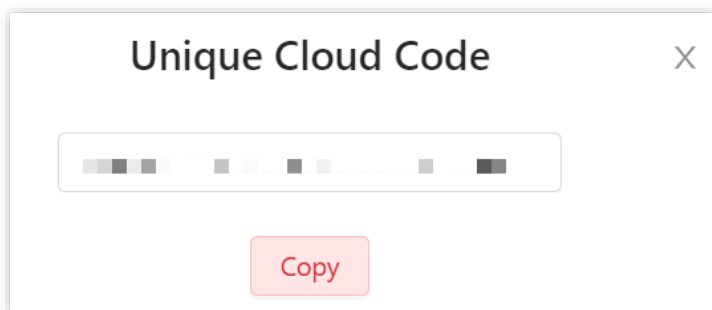

2. Enable the IMS Cloud Management function of the switch.

- (1) [Log in to the web UI of the switch.](#)
- (2) Click **Device Management > IMS Cloud Management**.
- (3) Enable the **IMS Cloud Management** function, paste the copied **Unique Cloud Code**, enable the **Report** function, and click **Apply**.

IMS Cloud Management

help

IMS Cloud Management

IMS Cloud Management

Apply

Unique Cloud Code

Unique Cloud Code is used to associate the device to your IMS Cloud account. You can obtain this code either on IMS Cloud (<https://imsen.ip-com.com.cn>) or from the Account Center of the IP-COM IMS app.

Report

Note: If disabled, the device can neither be managed nor maintained by IMS Cloud.

3. Log in to the IMS cloud platform and add the switch to a project.

- (1) Start a web browser, visit <https://imsen.ip-com.com.cn>, and log in to IP-COM IMS Cloud.
- (2) Click the personal avatar at the upper right corner and select **Device-Joining Alert**.
- (3) Locate this switch and add it to your project.

----End

After successful configuration, you can find the status of IMS Cloud Management on **System Management > System Info** page is **Connected**, which indicates that you can use the IMS cloud platform to remotely manage the switch.

System Info

Firmware Version	V64.22.14.7 (1218) build 2021-09-10 10:33:20	
Hardware Version	V1.0	
MAC Address	D838-0D03-0409	
Management VLAN	1	
Device Name	G3326P-24-410W	
DHCP Client	<input type="text" value="Enable"/>	▼
IP Address	<input type="text" value="192.168.5.93"/>	
Subnet Mask	<input type="text" value="255.255.255.0"/>	
Gateway	<input type="text" value="192.168.5.1"/>	
Primary DNS	<input type="text" value="192.168.5.1"/>	
Secondary DNS	<input type="text"/>	
Aging Time	<input type="text" value="300"/>	(60 to 3000 s)
IMS Cloud Management	Connected	

9.5.3 Management on IP-COM IMS app

1. Scan the following QR code or search for the IP-COM IMS app (app v1.3.1 is used for illustration below) in App Store or the app market to download and install the IP-COM IMS app on your mobile phone.

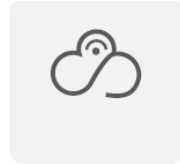

IP-COM IMS

2. Log in to the IP-COM IMS app. On the **Network** page, add a **Traditional WLAN** project.
 - Scan Code (recommended): Scan the **Scan to Add Device** QR code on the Ethernet port surface of the switch to automatically recognize project type and create project.
 - Manually Create: Manually choose project type and create project.

Scan Code method is used for illustration below.

(1) Create project.

① Click **Add Project**

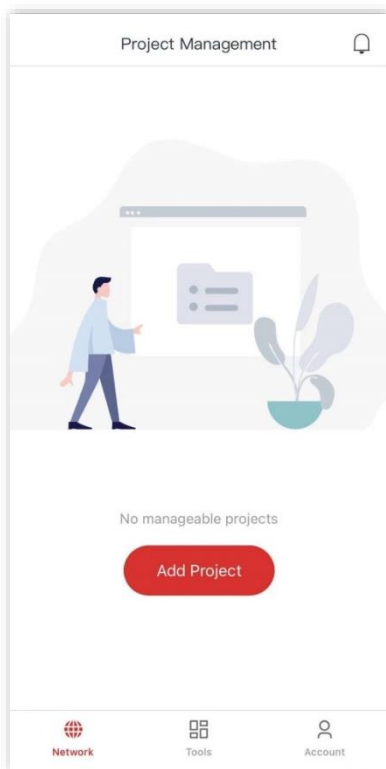

② Click **Scan Code**

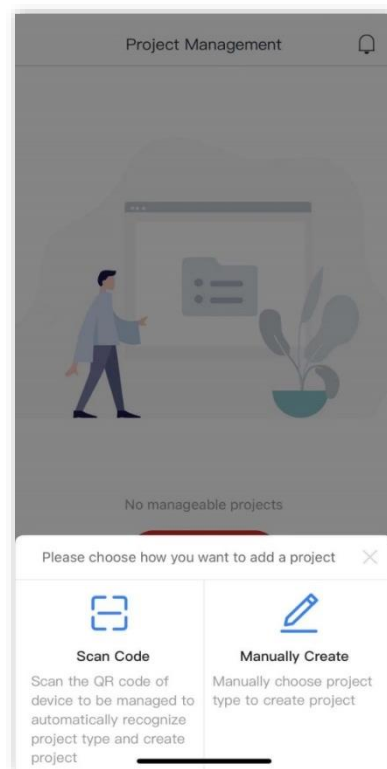

③ Scan the QR code on the switch



④ Project type is automatically recognized

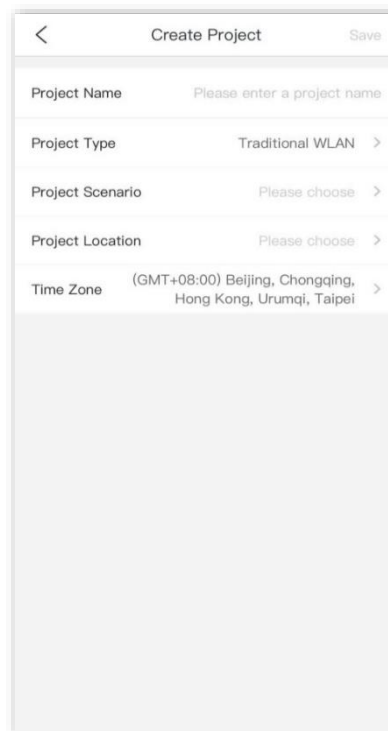

⑤ Set other project parameters and click **Save**

✓ Project created

(2) Add device.

① Enter the project, click **Add Device**.

② The following prompt appears

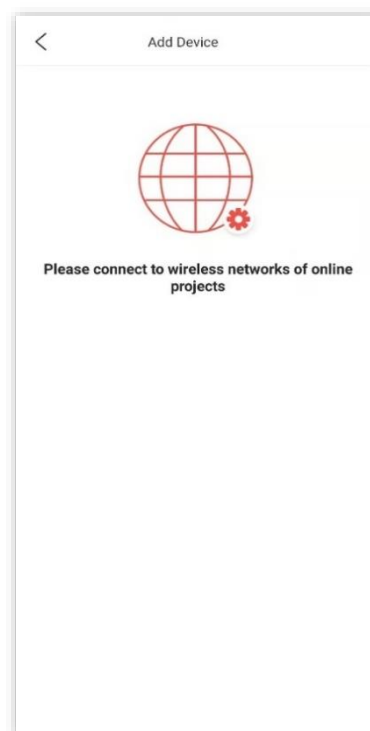
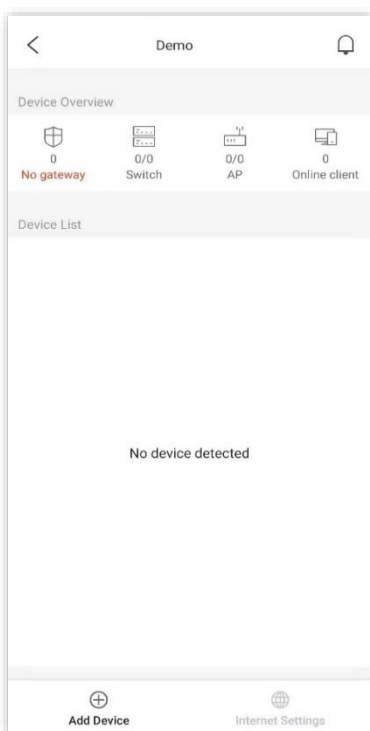

③ On the **Settings** page, connect to the WiFi network of the LAN where this switch is deployed (this WiFi network should have internet access)

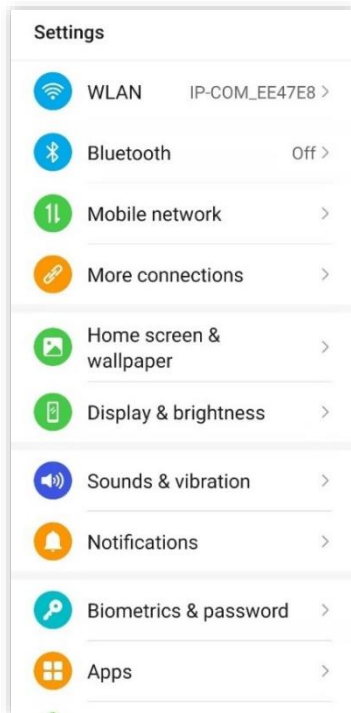

④ Go back to the app. Wait until the switch to be added is automatically detected, tick the switch, and tick **Agree to enable Cloud Management, and activate report function of the device** to add the switch

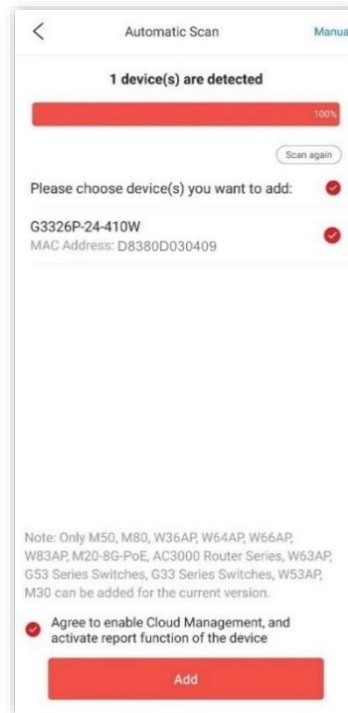

✓ The switch is added successfully

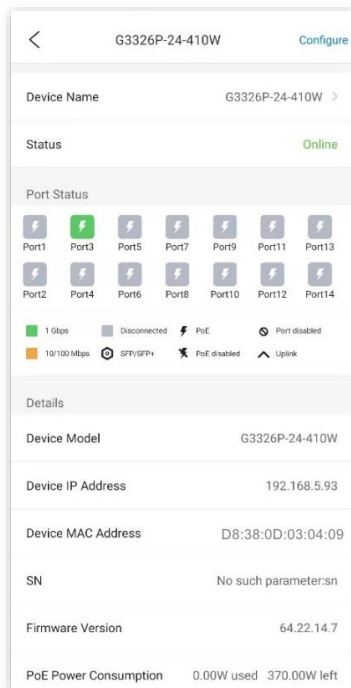

----End

You can manage and maintain the switch on IP-COM IMS app.

10 Configuration

Click **Configuration** to enter the page. On this page, you can back up system configurations and import configuration files.

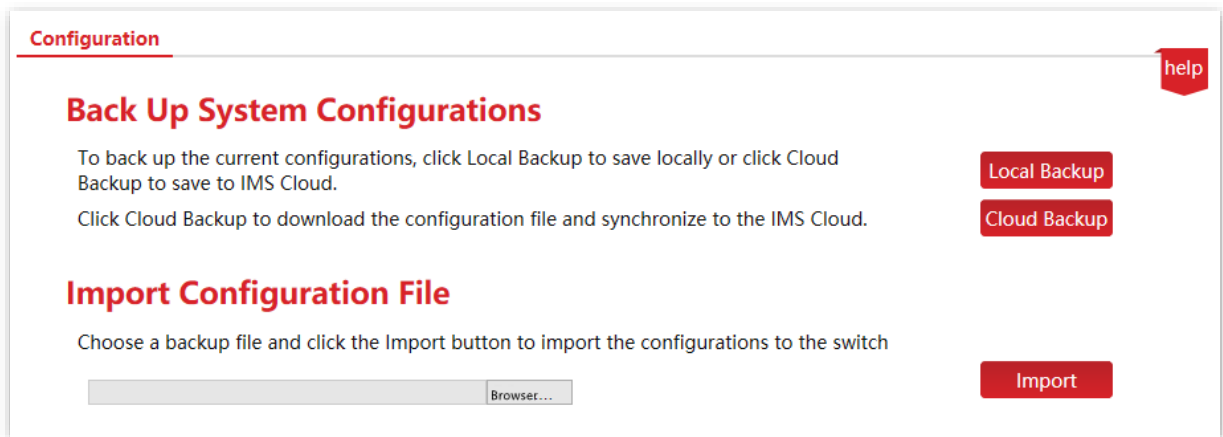

10.1 Back up system configurations

If you have made configurations to the switch for better performance, it is recommended to back up the configurations. After you upgrade the switch or restore the switch to factory settings, you can import this backup configuration file to restore the configurations to the switch.

The switch supports two backup methods: local backup and cloud backup.



- Please click **Save** on the upper right corner of the page to save all settings before backup.
- Only when the switch is managed by the IMS cloud platform can the configurations be backed up to the IMS cloud platform.

10.2 Import configuration file

If you need to make same configuration on several switches, or performance degradation of

switch occurs due to wrong operations, you can click **Import** to import the backup configuration file to the switch.

Appendix

Acronyms and Abbreviations

Acronym or Abbreviation	Full Spelling
BPDU	Bridge Protocol Data Unit
CRC	Cyclic Redundancy Check
DA	Destination Address
DHCP	Dynamic Host Configuration Protocol
DNS	Domain Name System
FDX	Full Duplex
FIFO	First Input First Output
HDX	Half Duplex
IP	Internet Protocol
LAN	Local Area Network
MAC	Medium Access Control
PoE	Power over Ethernet
PVID	Port-based VLAN ID
QoS	Quality of Service
RSTP	Rapid Spanning Tree Protocol
SA	Source Address
SP	Strict Priority
STP	Spanning Tree Protocol
TTL	Time to Live
VLAN	Virtual Local Area Network
WAN	Wide Area Network
WRR	Weighted Round Robin

Configure the switch to access the internet

Networking requirement

You want to configure the switch to access the internet.



The following shows the steps to access the internet when the switch's DHCP client is disabled.

(When the DHCP client is enabled, the switch automatically obtains IP address and other parameters from the upstream router.)

Assume that:

- LAN IP address/subnet mask of the upstream router: 192.168.1.1/255.255.255.0
- Primary & secondary DNS server address: 192.168.108.108, 192.168.108.110

The network topology is as shown below.

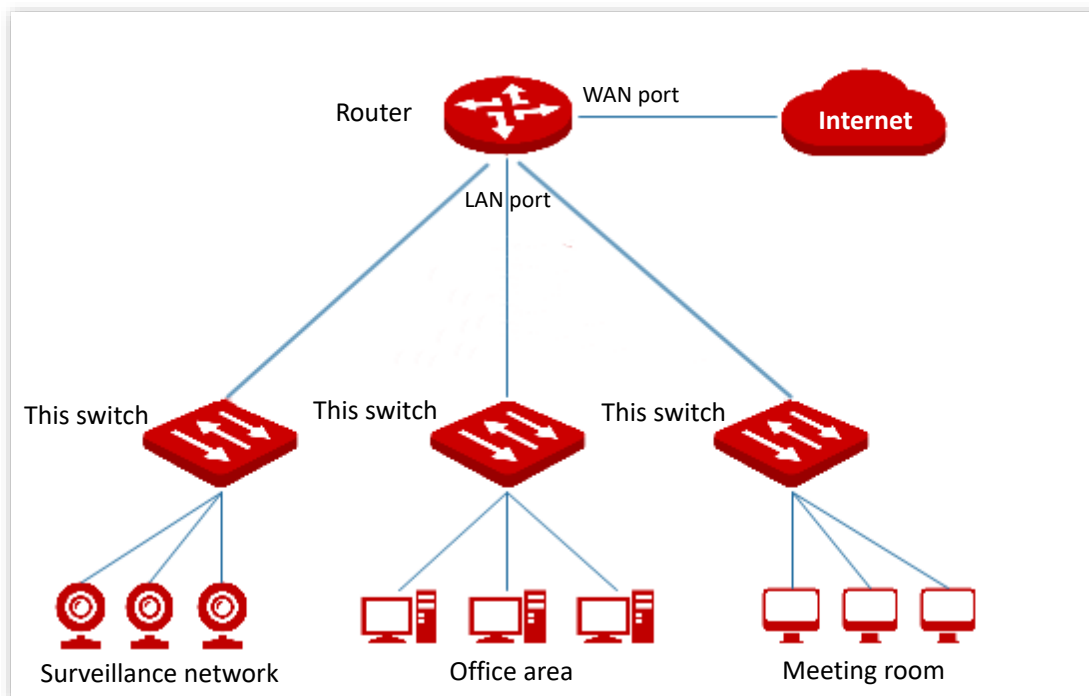

Configuration procedure

1. Log in to the web UI of the switch.
2. Configure the IP address, subnet mask, gateway and DNS server addresses of the switch.

- (1) Click **System Management > System Info**.
- (2) Set **IP Address** to an IP address in the same network segment as that of the LAN IP address of the router, which is **192.168.1.150** in this example.
- (3) Set **Subnet Mask** to **255.255.255.0**, **Gateway** to **192.168.1.1**.
- (4) Set the **Primary DNS** and **Secondary DNS** to DNS server addresses that can properly resolve the URL of the IMS cloud platform, which are **192.168.108.108**, **192.168.108.110** respectively in this example.
- (5) Click **Apply**.

Device Name	G3326P-24-410W	
DHCP Client	Disable	<input type="button" value="v"/>
IP Address	192.168.1.150	
Subnet Mask	255.255.255.0	
Gateway	192.168.1.1	
Primary DNS	192.168.108.108	
Secondary DNS	192.168.108.110	
Aging Time	300	(60 to 3000 s)
IMS Cloud Management	Disconnected	

----End

Verification

After configuration, you can test whether the switch can access the internet through the Ping test on **Device Management > Diagnosis** page.

You can ping a domain name to test the internet connection status, which is **www.bing.com** in this example. The switch accesses the internet successfully if the test results are as shown below.

Ping Test help

Target IP Address (Enter the IP address or domain name)

Transmit Times (Range: 1 to 100) Start

Packet Size B(Range: 18 to 512)

Detection Result

```

PING www.bing.com (www.bing.com): 64 data bytes
64 bytes from 202.89.233.100: seq=0 ttl116 time=40.000 ms
64 bytes from 202.89.233.100: seq=1 ttl116 time=70.000 ms
64 bytes from 202.89.233.100: seq=2 ttl116 time=40.000 ms
64 bytes from 202.89.233.100: seq=3 ttl116 time=120.000 ms
64 bytes from 202.89.233.100: seq=4 ttl116 time=50.000 ms
--- www.bing.com ping statistics ---
Packets: Send = 5, Received = 5, Lost = 0(loss 0%)
round-trip min/avg/max = 40.000/64/120.000 ms
          
```